

URB

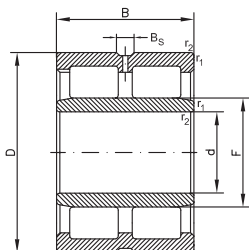



Double Row Cylindrical Roller Bearings



NNU49..W33

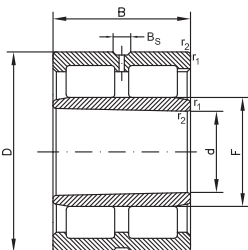

NNU49..K..W33

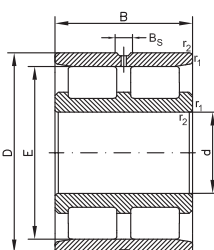

NN30..W33

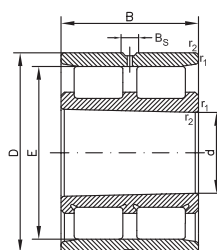

NN30..K..W33

| d | Dimensions | | | Basical radial load | | Speed limit | | Designation |
|----|------------|----|---|------------------------|--------------------------|-------------------|-------|--------------|
| | D | B | r ₁ , r ₂ min. | dyn. C _r | stat. C _{0r} | grease | oil | |
| mm | | | | kN | | min ⁻¹ | | |
| 30 | 55 | 19 | 1 | 29 | 34 | 16000 | 19000 | NN3006 MW33 |
| | 55 | 19 | 1 | 29 | 34 | 16000 | 19000 | NN3006 KMW33 |
| 35 | 62 | 20 | 1 | 39,3 | 50 | 14000 | 17000 | NN3007 MW33 |
| | 62 | 20 | 1 | 39,3 | 50 | 14000 | 17000 | NN3007 KMW33 |
| 40 | 68 | 21 | 1 | 45 | 58,5 | 12000 | 15000 | NN3008 MW33 |
| | 68 | 21 | 1 | 45 | 58,5 | 12000 | 15000 | NN3008 KMW33 |
| 45 | 75 | 23 | 1 | 54 | 72 | 11000 | 14000 | NN3009 MW33 |
| | 75 | 23 | 1 | 54 | 72 | 11000 | 14000 | NN3009 KMW33 |
| 50 | 80 | 23 | 1 | 57 | 80 | 10000 | 13000 | NN3010 MW33 |
| | 80 | 23 | 1 | 57 | 80 | 10000 | 13000 | NN3010 KMW33 |
| 55 | 90 | 26 | 1,1 | 72 | 100 | 9000 | 11000 | NN3011 MW33 |
| | 90 | 26 | 1,1 | 72 | 100 | 9000 | 11000 | NN3011 KMW33 |
| 60 | 95 | 26 | 1,1 | 75 | 110 | 8500 | 10000 | NN3012 MW33 |
| | 95 | 26 | 1,1 | 75 | 110 | 8500 | 10000 | NN3012 KMW33 |
| 65 | 100 | 26 | 1,1 | 76,5 | 118 | 8000 | 9500 | NN3013 MW33 |
| | 100 | 26 | 1,1 | 76,5 | 118 | 8000 | 9500 | NN3013 KMW33 |
| 70 | 110 | 30 | 1,1 | 98 | 151 | 7000 | 8500 | NN3014 MW33 |
| | 110 | 30 | 1,1 | 98 | 151 | 7000 | 8500 | NN3014 KMW33 |
| 75 | 115 | 30 | 1,1 | 100 | 156 | 6700 | 8000 | NN3015 MW33 |
| | 115 | 30 | 1,1 | 100 | 156 | 6700 | 8000 | NN3015 KMW33 |
| 80 | 125 | 34 | 1,1 | 120 | 186 | 6300 | 7500 | NN3016 MW33 |
| | 125 | 34 | 1,1 | 120 | 186 | 6300 | 7500 | NN3016 KMW33 |
| 85 | 130 | 34 | 1,1 | 125 | 200 | 6000 | 7000 | NN3017 MW33 |
| | 130 | 34 | 1,1 | 125 | 200 | 6000 | 7000 | NN3017 KMW33 |
| 90 | 140 | 37 | 1,5 | 141 | 224 | 5600 | 6700 | NN3018 MW33 |
| | 140 | 37 | 1,5 | 141 | 224 | 5600 | 6700 | NN3018 KMW33 |
| 95 | 145 | 37 | 1,5 | 146 | 236 | 5300 | 6300 | NN3019 MW33 |
| | 145 | 37 | 1,5 | 146 | 236 | 5300 | 6300 | NN3019 KMW33 |



Double Row Cylindrical Roller Bearings

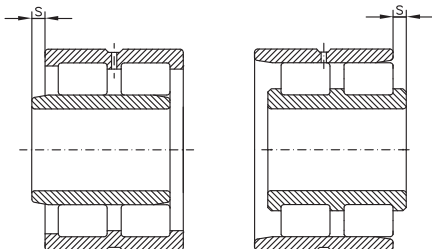

Abutment and fillet dimensions
see on page 269-270

| Bearing dimensions | | | | | Mass |
|--------------------|------|---|----------------|-----|------|
| d | E | F | B _s | s | |
| mm | | | | | [kg] |
| 30 | 48,5 | - | 4,8 | 1,4 | 0,12 |
| | 48,5 | - | 4,8 | 1,4 | 0,12 |
| 35 | 55 | - | 4,8 | 1,4 | 0,25 |
| | 55 | - | 4,8 | 1,4 | 0,25 |
| 40 | 61 | - | 4,8 | 1,4 | 0,33 |
| | 61 | - | 4,8 | 1,4 | 0,32 |
| 45 | 67,5 | - | 4,8 | 1,7 | 0,39 |
| | 67,5 | - | 4,8 | 1,7 | 0,38 |
| 50 | 72,5 | - | 4,8 | 1,7 | 0,42 |
| | 72,5 | - | 4,8 | 1,7 | 0,41 |
| 55 | 81 | - | 4,8 | 1,9 | 0,62 |
| | 81 | - | 4,8 | 1,9 | 0,60 |
| 60 | 86,1 | - | 4,8 | 1,9 | 0,67 |
| | 86,1 | - | 4,8 | 1,9 | 0,65 |
| 65 | 91 | - | 4,8 | 1,9 | 0,73 |
| | 91 | - | 4,8 | 1,9 | 0,71 |
| 70 | 100 | - | 6,5 | 2,3 | 1,03 |
| | 100 | - | 6,5 | 2,3 | 0,99 |
| 75 | 105 | - | 6,5 | 2,3 | 1,08 |
| | 105 | - | 6,5 | 2,3 | 1,05 |
| 80 | 113 | - | 6,5 | 2,5 | 1,51 |
| | 113 | - | 6,5 | 2,5 | 1,46 |
| 85 | 118 | - | 6,5 | 2,5 | 1,55 |
| | 118 | - | 6,5 | 2,5 | 1,50 |
| 90 | 127 | - | 6,5 | 2,5 | 2,15 |
| | 127 | - | 6,5 | 2,5 | 2,09 |
| 95 | 132 | - | 6,5 | 2,5 | 2,10 |
| | 132 | - | 6,5 | 2,5 | 2,03 |



Double Row Cylindrical Roller Bearings

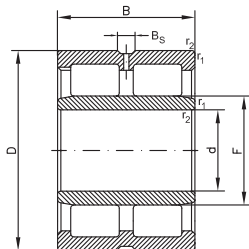

NNU49..W33

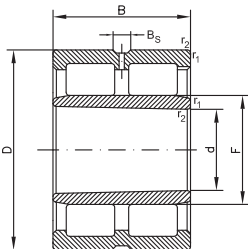

NNU49..K..W33

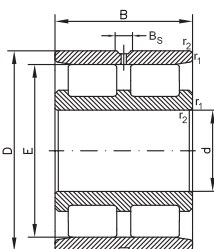

NN30..W33

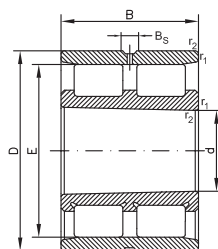

NN30..K..W33

| Dimensions | | | | Basical radial load | | Speed limit | | Designation |
|------------|-----|----|---|------------------------|--------------------------|-------------------|------|---------------|
| d | D | B | r ₁ , r ₂ min. | dyn. C _r | stat. C _{0r} | grease | oil | |
| mm | | | | kN | | min ⁻¹ | | |
| 100 | 140 | 40 | 1,1 | 129 | 255 | 5300 | 6300 | NNU4920 MW33 |
| | 140 | 40 | 1,1 | 129 | 255 | 5300 | 6300 | NNU4920 KMW33 |
| | 150 | 37 | 1,5 | 152 | 264 | 5300 | 6300 | NN3020 MW33 |
| | 150 | 37 | 1,5 | 152 | 264 | 5300 | 6300 | NN3020 KMW33 |
| 105 | 145 | 40 | 1,1 | 129 | 260 | 5300 | 6300 | NNU4921 MW33 |
| | 145 | 40 | 1,1 | 129 | 260 | 5300 | 6300 | NNU4921 KMW33 |
| | 160 | 41 | 2 | 192 | 310 | 4800 | 5600 | NN3021 MW33 |
| | 160 | 41 | 2 | 192 | 310 | 4800 | 5600 | NN3021 KMW33 |
| 110 | 150 | 40 | 1,1 | 132 | 270 | 5000 | 6000 | NNU4922 MW33 |
| | 150 | 40 | 1,1 | 132 | 270 | 5000 | 6000 | NNU4922 KMW33 |
| | 170 | 45 | 2 | 226 | 365 | 4500 | 5300 | NN3022 MW33 |
| | 170 | 45 | 2 | 226 | 365 | 4500 | 5300 | NN3022 KMW33 |
| 120 | 165 | 45 | 1,1 | 176 | 340 | 4500 | 5300 | NNU4924 MW33 |
| | 165 | 45 | 1,1 | 176 | 340 | 4500 | 5300 | NNU4924 KMW33 |
| | 180 | 46 | 2 | 235 | 405 | 4300 | 5000 | NN3024 MW33 |
| | 180 | 46 | 2 | 235 | 405 | 4300 | 5000 | NN3024 KMW33 |
| 130 | 180 | 50 | 1,5 | 193 | 390 | 4000 | 4800 | NNU4926 MW33 |
| | 180 | 50 | 1,5 | 193 | 390 | 4000 | 4800 | NNU4926 KMW33 |
| | 200 | 52 | 2 | 294 | 510 | 3800 | 4500 | NN3026 MW33 |
| | 200 | 52 | 2 | 294 | 510 | 3800 | 4500 | NN3026 KMW33 |
| 140 | 190 | 50 | 1,5 | 190 | 400 | 3800 | 4500 | NNU4928 MW33 |
| | 190 | 50 | 1,5 | 190 | 400 | 3800 | 4500 | NNU4928 KMW33 |
| | 210 | 53 | 2 | 305 | 520 | 3600 | 4300 | NN3028 MW33 |
| | 210 | 53 | 2 | 305 | 520 | 3600 | 4300 | NN3028 KMW33 |
| 150 | 210 | 60 | 2 | 326 | 655 | 3600 | 4300 | NNU4930 MW33 |
| | 210 | 60 | 2 | 326 | 655 | 3600 | 4300 | NNU4930 KMW33 |
| | 225 | 56 | 2 | 339 | 600 | 3400 | 4000 | NN3030 MW33 |
| | 225 | 56 | 2 | 339 | 600 | 3400 | 4000 | NN3030 KMW33 |

Double Row Cylindrical Roller Bearings

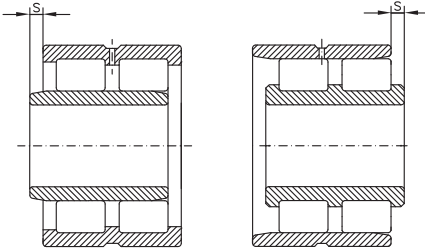

Abutment and fillet dimensions
see on page 269-270

| Bearing dimensions | | | | | Mass |
|--------------------|-----|-------|----------------|------|------|
| d | E | F | B _s | s | |
| mm | | | | | [kg] |
| 100 | - | 113 | 6,5 | 2 | 1,80 |
| | - | 113 | 6,5 | 2 | 1,72 |
| | 137 | - | 6,5 | 2,5 | 2,20 |
| | 137 | - | 6,5 | 2,5 | 2,13 |
| 105 | - | 118 | 6,5 | 1,5 | 2,07 |
| | - | 118 | 6,5 | 1,5 | 1,98 |
| | 146 | - | 6,5 | 2,6 | 2,84 |
| | 146 | - | 6,5 | 2,6 | 2,75 |
| 110 | - | 123 | 6,5 | 1,5 | 2,13 |
| | - | 123 | 6,5 | 1,5 | 2,04 |
| | 155 | - | 6,5 | 2,8 | 3,68 |
| | 155 | - | 6,5 | 2,8 | 3,56 |
| 120 | - | 134,5 | 6,5 | 1,5 | 2,76 |
| | - | 134,5 | 6,5 | 1,5 | 2,64 |
| | 165 | - | 6,5 | 3,1 | 3,96 |
| | 165 | - | 6,5 | 3,1 | 3,83 |
| 130 | - | 146 | 6,5 | 2 | 3,54 |
| | - | 146 | 6,5 | 2 | 3,37 |
| | 182 | - | 9,5 | 3,35 | 5,75 |
| | 182 | - | 9,5 | 3,35 | 5,57 |
| 140 | - | 156 | 6,5 | 2 | 4,24 |
| | - | 156 | 6,5 | 2 | 4,06 |
| | 192 | - | 9,5 | 3,35 | 6,38 |
| | 192 | - | 9,5 | 3,35 | 6,18 |
| 150 | - | 168,5 | 6,5 | 2,3 | 6,49 |
| | - | 168,5 | 6,5 | 2,3 | 6,21 |
| | 206 | - | 9,5 | 3,7 | 7,50 |
| | 206 | - | 9,5 | 3,7 | 7,26 |



Double Row Cylindrical Roller Bearings

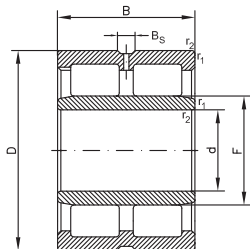

NNU49..W33

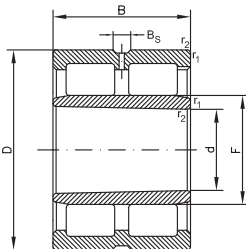

NNU49..K..W33

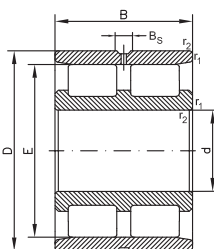

NN30..W33

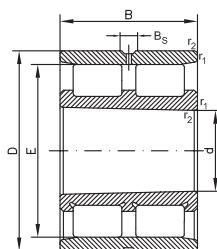

NN30..K..W33

| d | Dimensions | | | Basical radial load | | Speed limit | | Designation |
|-----|------------|----|---|------------------------|--------------------------|-------------------|------|---------------|
| | D | B | r ₁ , r ₂ min. | dyn. C _r | stat. C _{0r} | grease | oil | |
| mm | | | | kN | | min ⁻¹ | | |
| 160 | 220 | 60 | 2 | 335 | 680 | 3400 | 4000 | NNU4932 MW33 |
| | 220 | 60 | 2 | 335 | 680 | 3400 | 4000 | NNU4932 KMW33 |
| | 240 | 60 | 2,1 | 388 | 670 | 3200 | 3800 | NN3032 MW33 |
| | 240 | 60 | 2,1 | 388 | 670 | 3200 | 3800 | NN3032 KMW33 |
| 170 | 230 | 60 | 2 | 340 | 720 | 3200 | 3800 | NNU4934 MW33 |
| | 230 | 60 | 2 | 340 | 720 | 3200 | 3800 | NNU4934 KMW33 |
| | 260 | 67 | 2,1 | 458 | 810 | 3000 | 3600 | NN3034 MW33 |
| | 260 | 67 | 2,1 | 458 | 810 | 3000 | 3600 | NN3034 KMW33 |
| 180 | 250 | 69 | 2 | 405 | 877 | 3000 | 3600 | NNU4936 MW33 |
| | 250 | 69 | 2 | 405 | 877 | 3000 | 3600 | NNU4936 KMW33 |
| | 280 | 74 | 2,1 | 576 | 1080 | 2800 | 3400 | NN3036 MW33 |
| | 280 | 74 | 2,1 | 576 | 1080 | 2800 | 3400 | NN3036 KMW33 |
| 190 | 260 | 69 | 2 | 412 | 910 | 2800 | 3400 | NNU4938 MW33 |
| | 260 | 69 | 2 | 412 | 910 | 2800 | 3400 | NNU4938 KMW33 |
| | 290 | 75 | 2,1 | 614 | 1088 | 2600 | 3200 | NN3038 MW33 |
| | 290 | 75 | 2,1 | 614 | 1088 | 2600 | 3200 | NN3038 KMW33 |
| 200 | 280 | 80 | 2,1 | 490 | 1040 | 2600 | 3200 | NNU4940 MW33 |
| | 280 | 80 | 2,1 | 490 | 1040 | 2600 | 3200 | NNU4940 KMW33 |
| | 310 | 82 | 2,1 | 715 | 1271 | 2400 | 3000 | NN3040 MW33 |
| | 310 | 82 | 2,1 | 715 | 1271 | 2400 | 3000 | NN3040 KMW33 |
| 220 | 300 | 80 | 2,1 | 535 | 1321 | 2400 | 3000 | NNU4944 MW33 |
| | 300 | 80 | 2,1 | 535 | 1321 | 2400 | 3000 | NNU4944 KMW33 |
| | 340 | 90 | 3 | 890 | 1591 | 2200 | 2800 | NN3044 MW33 |
| | 340 | 90 | 3 | 890 | 1591 | 2200 | 2800 | NN3044 KMW33 |
| 240 | 320 | 80 | 2,1 | 556 | 1300 | 2200 | 2800 | NNU4948 MW33 |
| | 320 | 80 | 2,1 | 556 | 1300 | 2200 | 2800 | NNU4948 KMW33 |
| | 360 | 92 | 3 | 850 | 1560 | 2000 | 2600 | NN3048 MW33 |
| | 360 | 92 | 3 | 850 | 1560 | 2000 | 2600 | NN3048 KMW33 |

Double Row Cylindrical Roller Bearings

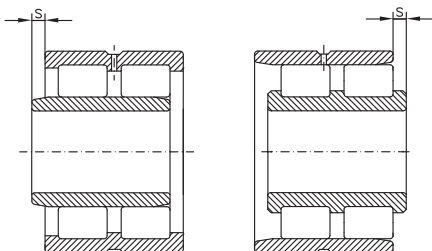

Abutment and fillet dimensions
see on page 269-270

| Bearing dimensions | | | | | Mass |
|--------------------|-----|-------|----------------|-----|------|
| d | E | F | B _s | s | |
| mm | | | | | [kg] |
| 160 | - | 178,5 | 6,5 | 2,3 | 6,67 |
| | - | 178,5 | 6,5 | 2,3 | 6,37 |
| | 219 | - | 9,5 | 4,2 | 9,42 |
| | 219 | - | 9,5 | 4,2 | 9,12 |
| 170 | - | 188,5 | 6,5 | 2,3 | 7,16 |
| | - | 188,5 | 6,5 | 2,3 | 6,85 |
| | 236 | - | 9,5 | 4,5 | 12,8 |
| | 236 | - | 9,5 | 4,5 | 12,4 |
| 180 | - | 202 | 9,5 | 2,6 | 10,6 |
| | - | 202 | 9,5 | 2,6 | 10,1 |
| | 255 | - | 12,2 | 4,8 | 16,9 |
| | 255 | - | 12,2 | 4,8 | 16,3 |
| 190 | - | 212 | 9,5 | 2,6 | 10,6 |
| | - | 212 | 9,5 | 2,6 | 10,1 |
| | 265 | - | 12,2 | 4,8 | 17,6 |
| | 265 | - | 12,2 | 4,8 | 17,1 |
| 200 | - | 225 | 12,2 | 3,4 | 16,5 |
| | - | 225 | 12,2 | 3,4 | 15,9 |
| | 282 | - | 12,2 | 5,3 | 23,1 |
| | 282 | - | 12,2 | 5,3 | 22,4 |
| 220 | - | 245 | 12,2 | 3,4 | 16,8 |
| | - | 245 | 12,2 | 3,4 | 16,1 |
| | 310 | - | 15 | 4,5 | 29,2 |
| | 310 | - | 15 | 4,5 | 28,2 |
| 240 | - | 265 | 12 | 3,4 | 18,0 |
| | - | 265 | 12 | 3,4 | 17,2 |
| | 330 | - | 15 | 6 | 31,9 |
| | 330 | - | 15 | 6 | 30,8 |



Double Row Cylindrical Roller Bearings

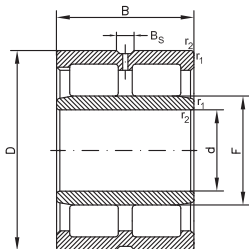

NUU49..W33

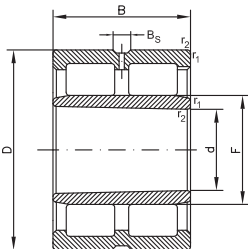

NUU49..K..W33

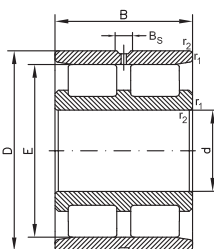

NN30..W33

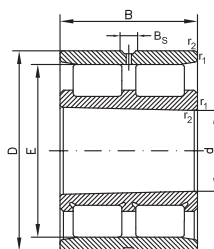

NN30..K..W33

| d | Dimensions | | | Basical radial load | | Speed limit | | Designation |
|-----|------------|-----|---|------------------------|--------------------------|-------------------|------|----------------------|
| | D | B | r ₁ , r ₂ min. | dyn. C _r | stat. C _{0r} | grease | oil | |
| mm | | | | kN | | min ⁻¹ | | |
| 260 | 360 | 100 | 2,1 | 750 | 1700 | 2000 | 2600 | NUU4952 MW33 |
| | 360 | 100 | 2,1 | 750 | 1700 | 2000 | 2600 | NUU4952 KMW33 |
| | 400 | 104 | 4 | 1060 | 2000 | 1900 | 2400 | NN3052 MW33 |
| | 400 | 104 | 4 | 1060 | 2000 | 1900 | 2400 | NN3052 KMW33 |
| 280 | 380 | 100 | 2,1 | 765 | 1800 | 1900 | 2400 | NUU4956 MW33 |
| | 380 | 100 | 2,1 | 765 | 1800 | 1900 | 2400 | NUU4956 KMW33 |
| | 420 | 106 | 4 | 1080 | 2080 | 1800 | 2200 | NN3056 MW33 |
| | 420 | 106 | 4 | 1080 | 2080 | 1800 | 2200 | NN3056 KMW33 |
| 300 | 420 | 118 | 3 | 1188 | 2943 | 1700 | 2000 | NUU4960 MW33 |
| | 420 | 118 | 3 | 1188 | 2943 | 1700 | 2000 | NUU4960 KMW33 |
| | 460 | 118 | 4 | 1270 | 2400 | 1600 | 1900 | NN3060 MW33 |
| | 460 | 118 | 4 | 1270 | 2400 | 1600 | 1900 | NN3060 KMW33 |
| 320 | 440 | 118 | 3 | 1060 | 2550 | 1600 | 1900 | NUU4964 MW33 |
| | 480 | 121 | 4 | 1320 | 2600 | 1600 | 1900 | NN3064 MW33 |
| 380 | 520 | 140 | 4 | 1705 | 4620 | 1100 | 1300 | NUU4976 MW33 |
| | 520 | 140 | 4 | 1705 | 4620 | 1100 | 1300 | NUU4976 KMW33 |
| 420 | 560 | 140 | 4 | 1786 | 5067 | 1000 | 1200 | NUU4984 MW33 |
| | 560 | 140 | 4 | 1786 | 5067 | 1000 | 1200 | NUU4984 KMW33 |

Double Row Cylindrical Roller Bearings

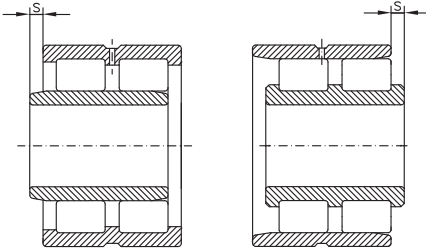

Abutment and fillet dimensions
see on page 269-270

| Bearing dimensions | | | | | Mass |
|--------------------|-----|-----|----------------|------|------|
| d | E | F | B _s | s | |
| mm | | | | | [kg] |
| 260 | - | 292 | 15 | 4 | 31,3 |
| | - | 292 | 15 | 4 | 29,9 |
| | 364 | - | 15 | 6,5 | 47,4 |
| | 364 | - | 15 | 6,5 | 45,9 |
| 280 | - | 312 | 15 | 4 | 32,7 |
| | - | 312 | 15 | 4 | 31,2 |
| | 384 | - | 15 | 6,75 | 51,2 |
| | 384 | - | 15 | 6,75 | 49,5 |
| 300 | - | 339 | 17,7 | 5 | 52,3 |
| | - | 339 | 17,7 | 5 | 50,1 |
| | 418 | - | 17,7 | 7,45 | 71,2 |
| | 418 | - | 17,7 | 7,45 | 69,1 |
| 320 | - | 359 | 17,7 | 5 | 52,6 |
| | 438 | - | 17,7 | 7,95 | 76,8 |
| 380 | - | 426 | 19,7 | 5,5 | 91,9 |
| | - | 426 | 19,7 | 5,5 | 88,1 |
| 420 | - | 466 | 19,7 | 5,5 | 96,3 |
| | - | 466 | 19,7 | 5,5 | 92,1 |



Cylindrical Roller Bearings, double row Non-standardized

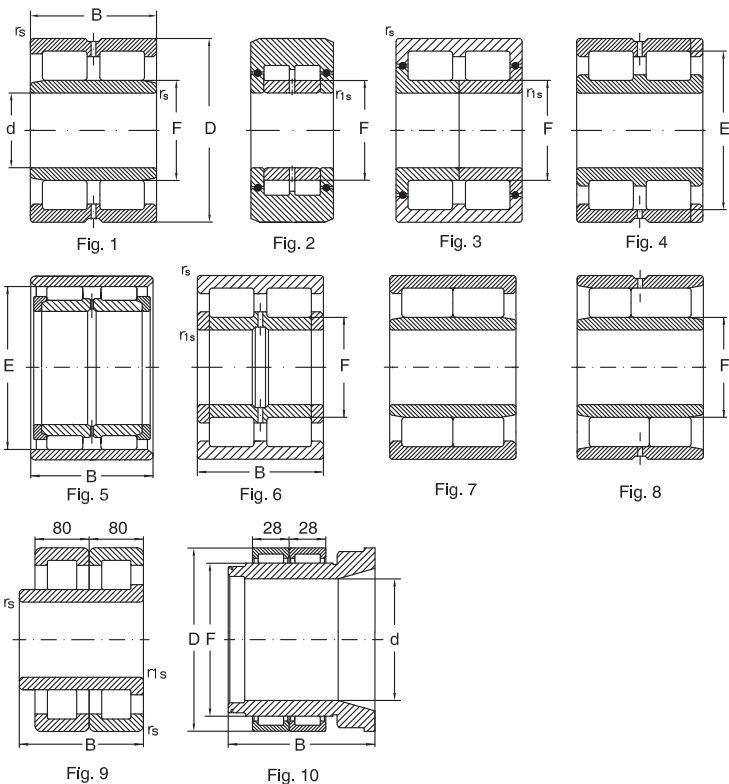

| Dimensions | | | | | | Fig. | Basical radial load | | Speed limit | | Mass | Designation |
|--------------|--------|-----|--------------|---------------|-------|------|---------------------|-------------------|-------------------|------|--------|------------------------|
| d | D | B | $r_{s \min}$ | $r_{1s \min}$ | E, F | | dyn. C_r | stat. C_{0r} | grease | oil | | |
| mm | | | | | | | kN | | min^{-1} | | | |
| 30 | 62 | 24 | 1 | 0,6 | 38 | 7 | 47,5 | 48,8 | 2400 | 3000 | 0,364 | 2NNU5106 M |
| 52 | 110 | 125 | 1,5 | 1 | 72 | 10 | 218 | 303 | 1900 | 2300 | 3,99 | 480911 |
| 120 | 190 | 80 | 1,1 | | 137 | 1 | 417 | 701 | 2400 | 3000 | 8,3 | NNU5124 M |
| 130 | 180 | 50 | 1,5 | 1,5 | 165,4 | 4 | 252 | 526 | 900 | 1300 | 3,9 | NNP4926 VW33 |
| | 250 | 194 | 3 | 9 | 158 | 9 | 1028 | 1660 | 800 | 1000 | 39,04 | 484126 |
| | 300,02 | 150 | 4 | 2 | 151,3 | 6 | 1148 | 1810 | 800 | 1000 | 59,97 | 488926 MA |
| 135 | 220 | 150 | | 1 | 194 | 5 | 650 | 1363 | 2700 | 3400 | 23,014 | LII-68853 |
| 150 | 300 | 120 | | 4 | 182 | 2 | 984 | 1645 | 800 | 1000 | 45,285 | NNUP5130 VC3W44 |
| | 300 | 120 | 6 | 4 | 184 | 3 | 817 | 1460 | 800 | 1000 | 47,55 | 493230 VC4 |
| 169,5 | 280 | 105 | 4 | | 197 | 1 | 800 | 2000 | 1700 | 2000 | 27,3 | NNU5134 MC5NA |
| 178 | 272 | 94 | 2 | | 203 | 1 | 883 | 1700 | 1700 | 2000 | 19,98 | 4877/178 M |
| 330 | 533,4 | 254 | 6 | | 393 | 8 | 3130 | 7755 | 560 | 800 | 246,7 | 489066 MC3NA |

Cylindrical roller bearings, multi rows

Non-standardized

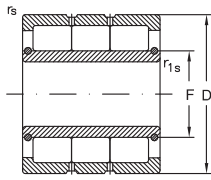

Fig. 1

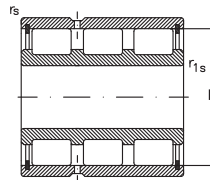

Fig. 2

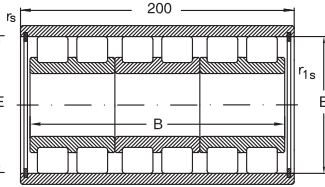

Fig. 3

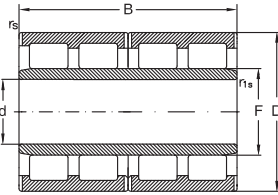

Fig. 4

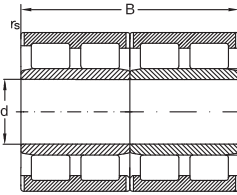

Fig. 5

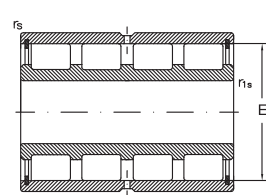

Fig. 6

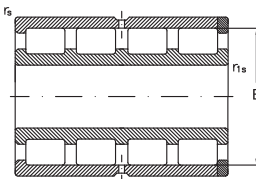

Fig. 7

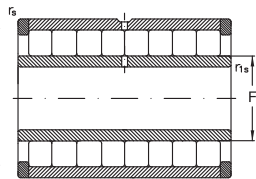

Fig. 8

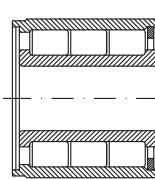

Fig. 9

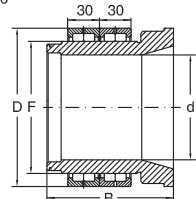

Fig. 10

| Dimensions | | | | | | Fig. | Basical radial load | | Speed limit | | Mass | Designation |
|---------------|-----|------|------------------|------------------|-------|------|---------------------|-------------------|-------------------|------|------|----------------------------|
| d | D | B | r_{fs} min. | r_{1s} min. | E, F | | dyn. C_r | stat. C_{0r} | grease | oil | | |
| mm | | | | | | | kN | | min ⁻¹ | | | |
| 65,019 | 110 | 140 | 1,5 | 1 | 86,9 | 10 | 218 | 474 | 5700 | 7200 | 4,1 | CR0113.13 V |
| 80 | 125 | 80 | 1,1 | 1,1 | 94,5 | 8 | 355 | 833 | 1700 | 2100 | 4,1 | NNU6016 VC3 |
| 90 | 125 | 68 | 1,5 | 1,5 | 115 | 6 | 258 | 602 | 1500 | 1900 | 2,7 | 4NN5118 VW33 |
| 130 | 182 | 81,5 | 2 | 2 | 170,4 | 9 | 495 | 1083 | 1200 | 1500 | 6,1 | 3NN5226 VP5 |
| 140 | 215 | 100 | 3 | 3 | 160,1 | 1 | 751 | 1576 | 2200 | 2600 | 13,7 | 3NNU5128 V |
| 145 | 210 | 155 | 2 | 2 | 166 | 4 | 790 | 1930 | 2400 | 3000 | 17,8 | 4NNU5129 PMC4W8 |
| 160 | 230 | 168 | 1,5 | 1,5 | 179 | 4 | 896 | 2202 | 2400 | 3000 | 23,6 | 4NNU5232 PMW8 |
| | 230 | 168 | 1,5 | 1,5 | 182 | 4 | 850 | 2215 | 2400 | 3000 | 23,9 | 4NNU5232 PMC4F182W8 |
| 170 | 230 | 180 | 1,5 | 2 | 215 | 3 | 995 | 2832 | 750 | 900 | 22 | 3NN5234 VC3 |
| 180 | 260 | 168 | 2,1 | 2,1 | 202 | 4 | 1105 | 2563 | 1700 | 2000 | 29,8 | 4NNU5136 PMC4W8 |
| 190 | 260 | 101 | 2 | 2 | 240,5 | 2 | 771 | 1924 | 750 | 900 | 16,2 | 3NN5138 VC3W33 |
| | 270 | 200 | 2,1 | 2,1 | 212 | 4 | 1330 | 3296 | 1600 | 2000 | 36,3 | 4NNU5138 PMW8 |
| 200 | 280 | 152 | 2,1 | 2,1 | 259,2 | 6 | 1130 | 2955 | 700 | 850 | 32,5 | 4NN5240 VC3W33 |
| | 280 | 152 | 2,1 | 2,1 | 259,2 | 7 | 1130 | 2955 | 700 | 850 | 32,5 | 4NNP5240 VC3W33 |
| | 290 | 192 | 2,1 | 2,1 | 226 | 4 | 1403 | 3387 | 1500 | 1800 | 44 | 4NNU5140 PMC3W8 |
| 230 | 330 | 206 | 2,1 | 2,1 | 260 | 4 | 1625 | 4014 | 1300 | 1600 | 63 | 4NNU5146 PMC4W8 |
| 240 | 360 | 218 | 3 | 1 | 272 | 5 | 1990 | 4763 | 1400 | 1800 | 83,1 | 4NU6040 EPDMW8 |
| 260 | 370 | 220 | 3 | 3 | 292 | 4 | 2018 | 5241 | 1200 | 1400 | 77,8 | 4NNU5152 PMC4W8 |
| | 370 | 220 | 3 | 3 | 292 | 4 | 2018 | 5241 | 1200 | 1400 | 77,8 | 4NNU5152 PMC4NAW8 |
| 280 | 390 | 220 | 3 | 3 | 312 | 4 | 2058 | 5470 | 1100 | 1300 | 82,8 | 4NNU5156 PMC3W8 |
| 300 | 460 | 290 | 4 | 1,5 | 341 | 5 | 3519 | 8469 | 1100 | 1300 | 188 | NNU6060 EPDMW8 |
| 320 | 840 | 290 | 4 | 1,5 | 360,8 | 5 | 3596 | 8858 | 950 | 1100 | 197 | NNU6064 EPDMW8 |



Set cylindrical roller bearings, double row Non-standardized

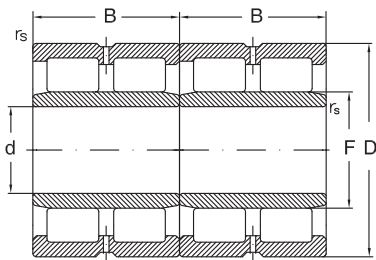

Fig. 1

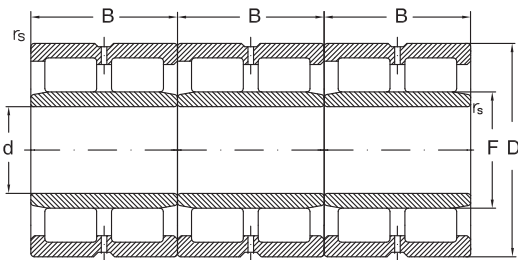

Fig. 2

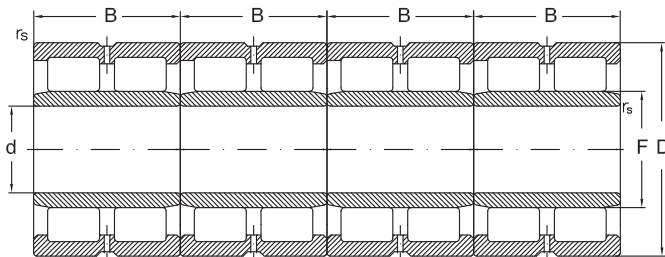

Fig. 3

| Dimensions | | | | | | Fig. | Basical radial load | | Speed limit | | Mass | Designation |
|------------|-----|-----|------------------------|------------------------|-----|------|------------------------|--------------------------|-------------------|------|-------|----------------------------|
| d | D | B | r _s min. | r _{1s} min | F | | dyn. C _r | stat. C _{0r} | grease | oil | | |
| mm | | | | | | | kN | | min ⁻¹ | | | |
| 260 | 360 | 100 | 2,1 | 2,1 | 292 | 2 | 1828 | 5535 | 1600 | 1900 | 93,9 | 3xNNU4952 MP53NAW33 |
| 300 | 420 | 118 | 3 | 3 | 339 | 1 | 2036 | 5886 | 1300 | 1600 | 104,6 | 2xNNU4960 MC3NAW33 |
| | 420 | 118 | 3 | 3 | 339 | 2 | 2772 | 8829 | 1300 | 1600 | 156,9 | 3xNNU4960 MC3NAW33 |
| 320 | 440 | 118 | 3 | 3 | 359 | 1 | 2115 | 6220 | 1300 | 1500 | 110,1 | 2xNNU4964 MC3NAW33 |
| 380 | 520 | 140 | 4 | 4 | 426 | 2 | 4007 | 13860 | 1100 | 1300 | 275,7 | 3xNNU4976 MC3NAW33 |
| 420 | 560 | 140 | 4 | 4 | 466 | 3 | 5156 | 20264 | 1000 | 1200 | 402,4 | 4xNNU4984 MC3NAW33 |

Cylindrical roller bearings without inner or outer ring

Non-standardized

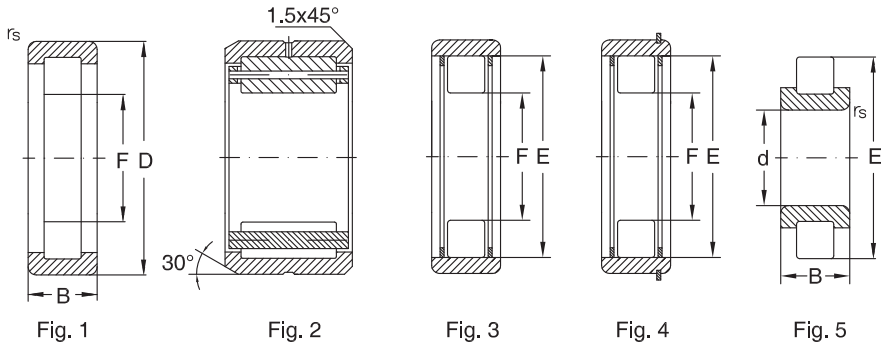

Fig. 1

Fig. 2

Fig. 3

Fig. 4

Fig. 5

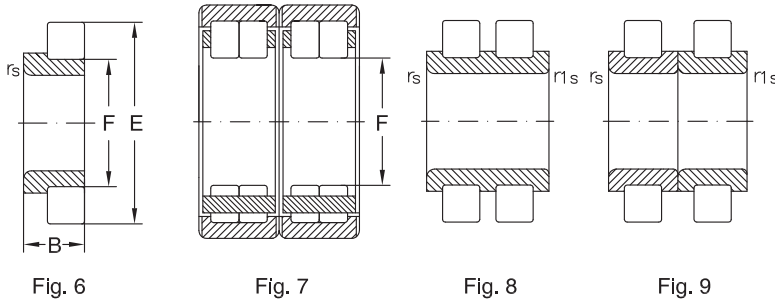

Fig. 6

Fig. 7

Fig. 8

Fig. 9

| Dimensions | | | | | | Fig. | Basical radial load | | Speed limit | | Mass | Designation |
|------------|----|-------|------------|---------------|--------|------|---------------------|----------------|-------------------|-------|-------|--------------------|
| d | D | B | r_s min. | r_{1s} min. | E, F | | dyn. C_r | stat. C_{0r} | grease | oil | | |
| mm | | | | | | | kN | | min ⁻¹ | | | |
| 22 | 52 | 15 | 0,7 | | 25 | 3 | 28,6 | 23,9 | 7000 | 14000 | 0,212 | RNU2R304 F2 |
| | | 22,5 | 1 | 0,3 | 38,75 | 8 | 34 | 35 | 3000 | 6000 | 0,107 | RNN5204 V |
| 30 | | 26 | 0,6 | | 60 | 5 | 77,4 | 84,1 | 5000 | 10000 | 0,361 | RN5506 M |
| | | 62 | 20 | 1 | 37,2 | 1 | 61 | 66,3 | 5000 | 10000 | 0,222 | RNU2206 VH |
| 40 | | 35,5 | 3 | 0,5 | 61,74 | 8 | 101 | 136 | 1700 | 3400 | 0,334 | RNN5408 V |
| | | 39,5 | 3 | 0,5 | 61,74 | 8 | 112 | 164 | 1700 | 3400 | 0,354 | RNN40x61,74x39,5 V |
| | | 78 | 14 | 3 | 40,025 | 1 | 29 | 31 | 1700 | 3400 | 0,333 | 496208 |
| | | 80 | 30,16 | 1,1 | 49,93 | 1 | 88 | 107 | 1700 | 3400 | 0,573 | RNU5208 M6 |
| 50 | | 40 | 2,5 | 1 | 75,25 | 8 | 134 | 204 | 2900 | 3600 | 0,62 | RNN5110 V |
| | | 90 | 23 | 1,5 | 45,02 | 4 | 68,6 | 59,7 | 2900 | 3600 | 0,585 | 490907 |
| | | 95 | 34 | | 68 | 2 | 144,3 | 205 | 2900 | 3600 | 0,831 | 35914 |
| | | 100 | 21 | 1 | 66,92 | 1 | 70,4 | 82,6 | 3500 | 7000 | 0,554 | RNU5311 |
| | | 100 | 33,33 | 1,5 | 66,95 | 1 | 99,2 | 129 | 3500 | 7000 | 0,912 | RNU5411 M |
| 60 | | 100 | 33,33 | 1 | 66,95 | 3 | 99,2 | 129 | 3500 | 7000 | 0,818 | RNU2R5411 |
| | | 26 | 1,1 | | 86,74 | 5 | 108 | 150 | 2400 | 4800 | 0,42 | RN3012 V |
| | | 28,53 | 2 | 0,3 | 127 | 6 | 177 | 182 | 2400 | 4800 | 1,86 | RNUPJ5112 M |
| | | 102 | 61 | 1,5 | 60 | 1 | 234 | 356 | 2300 | 2900 | 2,19 | RNU5212 V |



Cylindrical roller bearings without inner or outer ring Non-standardized

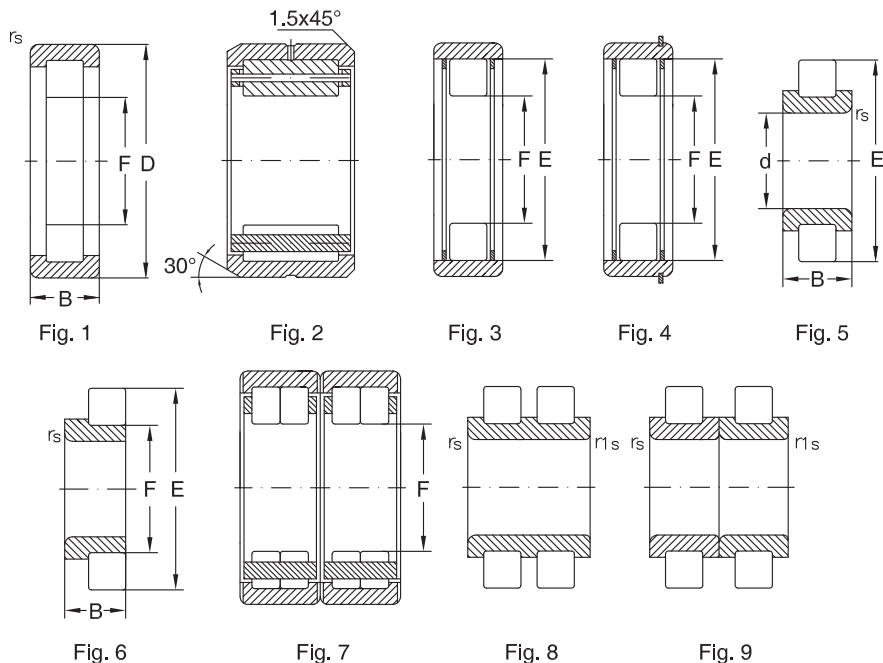

| Dimensions | | | | | | Fig. | Basical radial load | | Speed limit | | Mass | Designation |
|------------|-----|-------|------------------------|------------------------|---------|------|------------------------|--------------------------|-------------------|------|--------|----------------------|
| d | D | B | r _s min. | r _{1s} min | E, F | | dyn. C _r | stat. C _{0r} | grease | oil | | |
| mm | | | | | | | kN | | min ⁻¹ | | | |
| 60 | 120 | 38,1 | 1 | | 80,48 | 3 | 140 | 187 | 2600 | 5300 | 1,32 | RNU2R5513 |
| | 120 | 38,1 | 1 | | 80,48 | 1 | 140 | 187 | 2600 | 5300 | 1,53 | RNU513 MA |
| | 140 | 44,45 | 2 | | 95,36 | 1 | 136 | 259 | 2400 | 4500 | 2,25 | RNU5116 M |
| | 170 | 55,56 | 2 | | 113,6 | 1 | 327 | 453 | 1900 | 3800 | 4,51 | RNU5119 M |
| | 215 | 76,2 | 2 | | 145,23 | 1 | 569 | 878 | 1500 | 3000 | 9,66 | RNU5124 M |
| | 225 | 156 | 2 | | 169 | 7 | 1031 | 2255 | 1500 | 3000 | 17,18 | RNNU6029 PMW8 |
| 75 | | 62 | 3,5 | 1,5 | 115,78 | 9 | 312 | 481 | 1000 | 2200 | 2,146 | 489715 V |
| 90 | | 72 | 5 | 1,5 | 130,11 | 8 | 341 | 562 | 1000 | 2200 | 2,78 | RNN90x130,11x72 VW26 |
| 95 | | 55,56 | 3,3 | | 151,252 | 5 | 330 | 475 | 1000 | 2200 | 3,749 | 470519 M |
| 130 | | 110 | 4 | | 269,55 | 5 | 1400 | 1900 | 750 | 1600 | 27,452 | 000012-70330 |
| 710 | | 74 | 4 | | 825,6 | 5 | 1966 | 5303 | 120 | 260 | 60,213 | 1110376 |